

Article number: 439700240

Description: Rota-fix shaft-hub connection FL240x355

Note: Self centering - very high torque

Measures

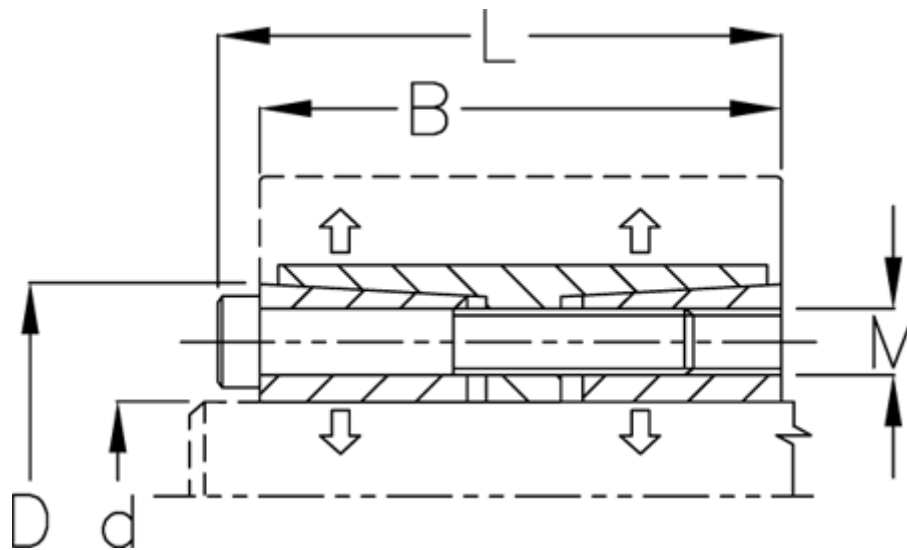

B mm	= 238
d H8 mm	= 240
D mm	= 355
Fit tolerance	= Aksel h8, Nav H8
F kN torque	= 3283.0
L mm	= 262
M mm	= M22
P N/mm ² surface pressure on shaft/hub	= 125

Surface roughness	= R? ? 3.2 μm
T N m torque	= 394000
Ts N m bolt tightening torque	= 1200.0